



**MJ-GERÜST**  
Scaffolding Systems

**SCAFFOLDING MADE IN  
PLETTENBERG**

# COMBI



PRICES | EDITION 10.2022

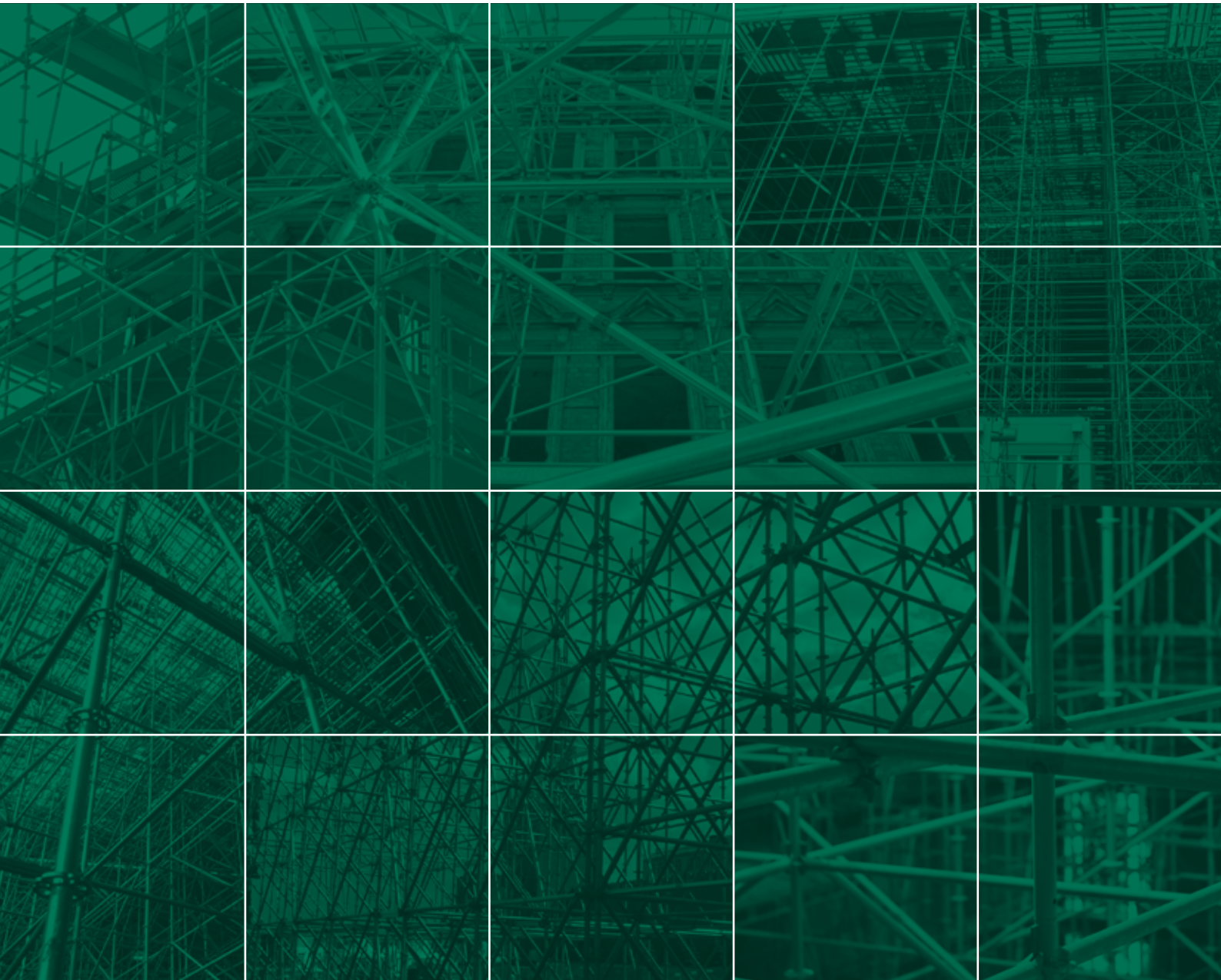

## SCAFFOLDINGS MADE IN PLETTENBERG

MJ-Gerüst GmbH, based in Plettenberg in the German region of Sauerland, is part of a strong group of companies, which can look back on more than 50 years of company history. The core competence of the family company lies in the production and worldwide distribution of high-quality steel and aluminum scaffolding systems, which offer almost limitless possibilities in the field of modern system scaffolding construction.

With a unique range of products and a wide range of universal accessories, we offer our customers the option of completing existing scaffolding material in a system-compatible complement. A highly valued advantage by our customers that has given our scaffolding international recognition and prominence.

Development, production and sales. These are the cornerstones of our range of services, which are supplemented by numerous additional services. Especially our support in the planning and implementation of difficult projects is claimed. A service in which our technical know-how and experience can often contribute to considerable time and cost savings.

Only through qualified work can a safe quality product be created. Our proven quality management reflects our knowledge and experience and makes the quality of our products measurable. In order to guarantee our high quality standards, our production processes are constantly accompanied by external examination offices and engineers.



## OUR COMPANY - YOUR BENEFITS

- Production in Germany at the location Plettenberg
- System compatible, high quality and norm compliant scaffold systems
- Certifications according to DIN EN 9001, 14001 and 50001
- Highest product quality through dynamic quality management
- Short-term availability of material due to high storage capacities and short decision-making processes
- Use of the modern production technology and permanent optimization of technological production running
- Project support already in the planning phase

## PARTNER AND CERTIFICATES





The system	04
Superior load values	06
Base jacks	08
Vertical standards	10
Protection / Protective elements	13
Horizontal ledgers	14
Diagonal bracing	18
Horizontal diagonal bracing	19
Decks	21
Climb up	26
Stair tower	31
Deck fastenings	34
Toe boards	35
Brackets	37
Couplers, Scaffold tubes	40
Anchoring	43
The safety enclosure OPTI-BOARD	44
Storage and transport	46
Securing during assembly of the scaffold	48
Notes	50
Order form	51

 Made in Plettenberg

 Net price, not discountable

 European standard

 Grant BG BAU

 Individual identification

 Delivery time on request

All prices exclude VAT applicable at the time of shipment. All dimensions and weights are non-binding approximate values. Technical data is subject to change without prior notice. Prices are charged as applicable on the day of shipment. Sale is subject exclusively to our sales terms and delivery conditions. An excerpt: place of business and jurisdiction is Plettenberg. Extended retention of title until full payment of all outstanding claims. Our prices are ex works.

## COMBI: FAST - STRONG - FLEXIBLE

With the modular scaffolding COMBI, we have developed a system that covers all requirements of constructive scaffolding. COMBI is based on the proven and flexible functionality of the modular perforated disc. For the construction of the knot design, we used the finite element method (FEM) in order to achieve stress-optimized lifting capacity and weight reduction at the same time. In addition, this resulted in an optimized load application via the ledgers into the standards.

As a result, the COMBI convinces with its exceptional static values. With up to eight connections per knot – freely selectable in heights of 0.50 m intervals – the system offers the highest possible variability in constructing a modular scaffold. The small notches of the perforated disc are used to connect the ledgers and enforce a 90-degree angle, which is required for many forms of application.

In connection with the larger notches arranged in between, the system also offers variable assembly options for angles outside the 90-degree. The decisive benefit of the modular scaffold – apart from the freely definable angles of knots – is the option for individual selection of bay lengths, widths and level heights. This enables flexible adjustments to virtually any type of building or construction.



### EFFICIENT

due to optimized ease of assembly



### PROFITABLE

through long life and excellent value retention



### FLEXIBLE

through countless field lengths/widths



### VERSATILE

through extensive range of accessories

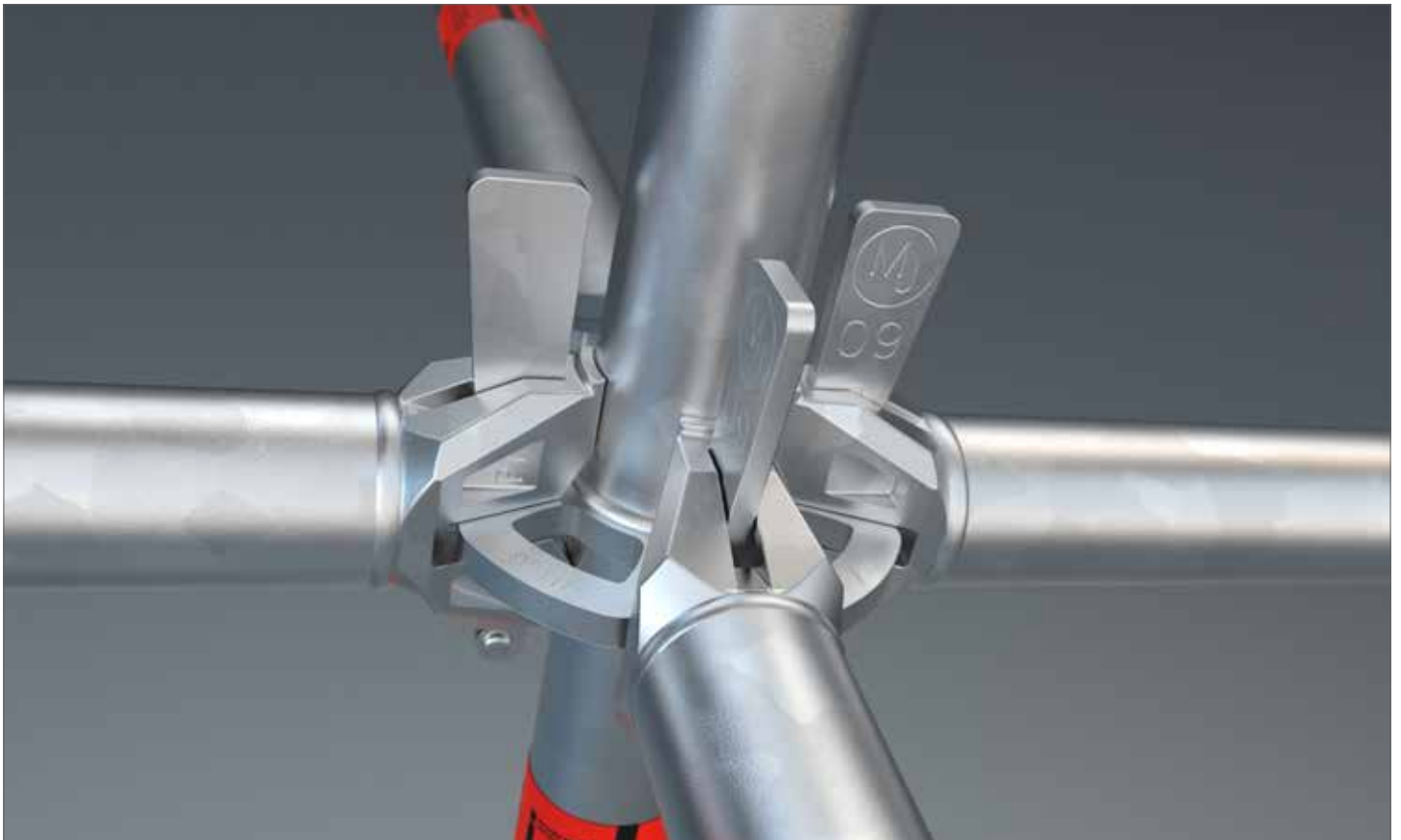



## THE ESSENTIAL BENEFITS OF THE SYSTEM IN OVERVIEW

There are many reasons for choosing the COMBI modular scaffolding system: not least of these is its extensive range of series-manufactured components, for example, crossbars and diagonals in more than 100 different lengths, as well as brackets in various widths - making the COMBI an 'allrounder' in its field. The use of system base crossbars allows standard scaffolding decks of various facade scaffold systems to be integrated without any difficulty.

Gen. approved by building inspection, also for common, manufacturer independent use. For details on type and scope, please refer to the approval models: Z-8.22-921, Z-8.22-923, Z-8.22-926, Z-8.22-960.



Visit us on



[WWW.GERUESTLAGER.DE](http://WWW.GERUESTLAGER.DE)

**COMBI, STEEL: LOAD CAPACITY**

Ledger type	O-ledger													O-ledger reinforced		O-double ledger			
Ledger length (system dimension) [m]	0.39	0.42	0.73	1.04	1.09	1.29	1.40	1.54	1.57	2.07	2.57	3.07	4.14	1.09	1.29	1.57	2.07	2.57	3.07
Evenly distributed line load (q) [kN/m]	80.7	70.0	24.3	12.7	11.6	8.5	7.3	6.1	5.9	3.5	2.3	1.6	0.9	18.5	16.8	14.9	9.9	7.5	5.3
Single load (P) in the centre of the bay [kN]	17.3	15.9	9.0	6.4	6.1	5.2	4.9	4.5	4.3	3.4	2.7	2.3	1.7	12.1	9.5	14.4	9.8	7.5	5.5

Ledger type	U-ledger*			U-ledger reinforced*				U-double ledger*											
Ledger length (system dimension) [m]	0.42		0.73	1.04		1.09		1.4		1.54		1.57		2.07		2.57		3.07	
Evenly distributed line load (q) [kN/m]	61.1		23.6	13.06		16.9		12.6		11.5		14.3		9.6		7.2		5.5	
Single load (P) in the centre of the bay [kN]	13.9		9.4	6.7		12.3		9.4		8.6		13.1		8.9		8.2		5.7	

**COMBI METRIC, STEEL: LOAD CAPACITY**

Ledger type	O-ledger													O-ledger reinforced		O-double ledger				
Ledger length (system dimension) [m]	0.25	0.41	0.5	0.74	0.75	1.0	1.1	1.25	1.39	1.5	2.0	2.5	3.0	4.0	1.39	1.5	1.5	2.0	2.5	3.0
Evenly distributed line load (q) [kN/m]	174.0	72.0	50.0	23.9	23.3	13.6	12.1	8.9	7.3	6.4	3.7	2.4	1.7	0.9	14.7	12.9	16.1	10.5	7.7	5.7
Single load (P) in the centre of the bay [kN]	27.5	16.2	13.3	8.9	8.8	6.7	6.3	5.4	4.9	4.5	3.5	2.8	2.4	1.8	11.3	8.1	15.9	10.4	8.1	5.7

**COMBI, STEEL: PERMISSIBLE LOAD CLASSES FOR DECK LEVELS**

Ledger length [m]	Bay length L [m] - double-sided (d) - single-sided (s)							
	1.57		2.07		2.57		3.07	
	d	s	d	s	d	s	d	s
O-ledger reinforced								
1.09	6	6	6	6	5	6	5	6
1.29	6	6	6	6	5	6	5	6
O-double ledger								
1.57	6	6	5	6	5	6	4	6
2.07	5	6	4	6	4	5	3	5
2.57	4	6	4	5	3	5	3	4
3.07	3	5	3	4	2	4	1	3

**COMBI METRIC, STEEL: PERMISSIBLE LOAD CLASSES FOR DECK LEVELS**

Ledger length [m]	Bay length L [m] - double-sided (d) - single-sided (s)							
	1.50		2.00		2.50		3.00	
	d	s	d	s	d	s	d	s
O-ledger reinforced								
1.39	6	6	5	6	5	6	4	6
1.50	6	6	5	6	4	6	4	6
O-double ledger								
1.50	6	6	5	6	5	6	4	6
2.00	5	6	5	6	4	6	3	5
2.50	4	6	4	5	3	5	3	5
3.00	3	5	3	4	2	4	2	3

**COMBI, STEEL: PERMISSIBLE LOAD CLASSES FOR DECK LEVELS**

Ledger length [m]	U-ledger				Ledger length [m]	U-ledger reinforced				Ledger length [m]	U-double ledger			
	Bay length L [m]					Bay length L [m]					Bay length L [m]			
	1.57	2.07	2.57	3.07		1.57	2.07	2.57	3.07		1.57	2.07	2.57	3.07
0.42	6	6	6	6	1.09	6	6	5	5	1.57	6	5	5	4
0.73	6	6	6	5	1.40	5	5	4	4	2.07	5	4	4	3
1.04	5	5	4	4	1.54	5	4	4	4	2.57	4	4	3	3
										3.07	3	3	2	1

All loads indicated here are permissible working loads. \*For even, double-sided loading

**LOAD CAPACITIES\* IN THE COMBI LEDGER AND DIAGONAL CONNECTION IN ACC. WITH APPROVAL Z-8.22-921: MJ COMBI**

**BENDING MOMENT  $M_y$**

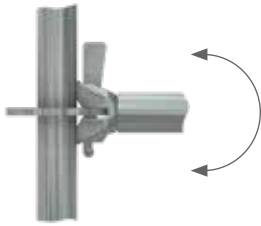

$M_{y,R,d} = \pm 110.0 \text{ kNcm}$

**NORMAL FORCE N**

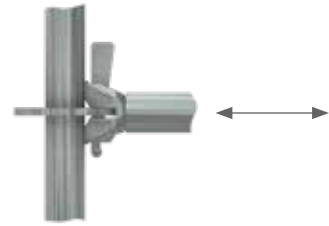

$VN_{R,d} = \pm 33.0 \text{ kN}$

**TORSIONAL MOMENT  $M_t$**

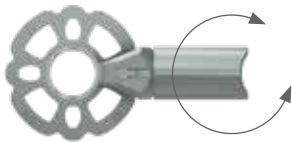

$M_{t,R,d} = \pm 64.3 \text{ kNcm}$ , only O-ledger

**HORIZONTAL SHEAR FORCE  $V_y$**



$V_{y,R,d} = \pm 17.3 \text{ kN}$

**BENDING MOMENT  $M_z$**



$M_{z,R,d} = \pm 45.0 \text{ kNcm}$

**NORMAL FORCE  $N_y$  DIAGONAL FOR BAY HEIGHT 2,00 M**

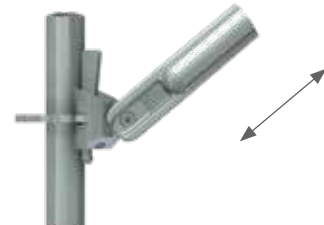

**VERTICAL SHEAR FORCE  $V_z$**

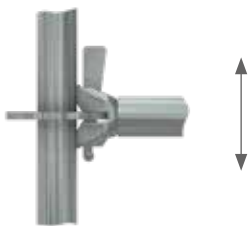

Vertical shear force, single connection: O-ledger:  $V_{z,R,d} = \pm 38.3 \text{ kN}$   
 U-ledger:  $V_{z,R,d} = \pm 32.1 \text{ kN}$

**TENSION - NORMAL FORCE**

Bay length [m]	0.73	1.09	1.40	1.57	2.07	2.57	3.07	4.14
$N_{y,R,d}$ [kN]	15.9	16.6	17.5	18.1	18.5	18.5	18.5	18.5

**PRESSURE - NORMAL FORCE**

Bay length [m]	0.73	1.09	1.40	1.57	2.07	2.57	3.07	4.14
$N_{y,R,d}$ [kN]	-16.3	-16.8	-15.3	-14.9	-13.7	-12.2	-10.6	-6.0

A separate certificate for the perforated disc is not required.

\*The loading capacity corresponds to the component resistance  $R_d$  (contains partial safety factor  $\gamma_M$ ) 'permissible loads' or 'working loads' are obtained by dividing the loading capacity  $\gamma_F = 1.5$ .

**BASE JACK**

EN

- Steel, hot dip galvanized
- With tube spindle
- Base plate 150 x 150 mm
- For adjusting level with differences in height of the underground
- Knurled nut with collar for centring the shaft on the spindle
- Lock to prevent unscrewing of the knurled nut and to ensure the necessary bridging length
- Can be used as a head spindle



Length (m)	Weight (kg)	PU (pcs.)	Article no.	Price (€)
0,30	2,40	375	000318	17,80
0,50	3,10	300	000319	21,30
0,60	3,40	300	000320	22,00
0,78	3,90	250	000321	29,80
1,00	4,70	200	000322	35,70

**SWIVEL BASE JACK**

EN

- Steel, hot dip galvanized
- With tube spindle
- Swiveling base plate 150 x 150 mm
- For adjusting level with differences in height of the underground
- Knurled nut with collar for centring the shaft on the spindle
- Lock to prevent unscrewing of the knurled nut and to ensure the necessary bridging length
- Can be used as a head spindle
- Additional longitudinal scaffold bracing required at in the base
- Permissible load: 25.4 kN



Length (m)	Weight (kg)	PU (pcs.)	Article no.	Price (€)
0,50	3,10	250	000323	46,30
0,80	4,30	200	013292	54,50

**BASE JACK SOLID**

EN

- Steel, hot dip galvanized
- Base plate 150 x 150 mm
- For adjusting level with differences in height of the underground
- Knurled nut with collar for centring the shaft on the spindle
- Can be used as a head spindle
- Without stoppers
- Permissible load:  $N_{pl,Rd} = 197 \text{ kN}$ ,  $M_{pl,Rd} = 105 \text{ kNm}$ ,  $V_{pl,Rd} = 85,2 \text{ kN}$



Length (m)	Weight (kg)	PU (pcs.)	Article no.	Price (€)
0,60	6,70	200	007095	47,50



## SPINDLE SECURITY



- Steel, hot dip galvanized
- With half coupler
- Serves for securing spindle and castor with spindle when moving a scaffold with a crane

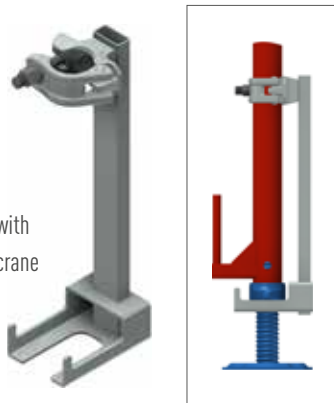

Height (m)	Weight (kg)	A/F	PU (pcs.)	Article no.	Price (€)
0,40	2,00	19	200	010294	30,20

## BASE PLATE



- Steel, hot dip galvanized
- Base plate 150 x 150 mm
- With tube support approx. 60 mm high
- Directs the load from the standards to the foundation

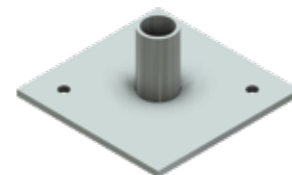

Weight (kg)	Article no.	Price (€)
1,00	000090	17,20

## SPINDLE FASTENING WITH WEDGE HEAD



- Steel, hot-dip galvanized
- Securing the base jack (and the starting collar) when lifting the scaffold with a crane
- Not suitable as a lift protection



Length (m)	Weight (kg)	PU (pcs.)	Article no.	Price (€)
0,64	2,40	200	007165	30,90

## PROTECTIVE PAD FOR BASE JACK

- Plastic
- With reflector

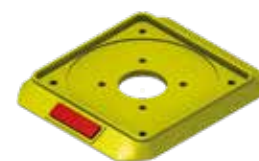

PU (pcs.)	Article no.	Price (€)
80	008110	4,40

## HEAD JACK

- Steel, hot dip galvanized
- Supporting element for support and platform scaffolding as well as for formwork scaffolds
- Used to hold squares timbers, laminated beams and formwork beams



Opening dimension (mm)	Weight (kg)	PU (pcs.)	Article no.	Price (€)
148	5,60	200	000693	40,60
180	8,30	-	011537	49,90

## UNDERLAY WOODS

- As a load-distributing support
- Sawn
- Dimension +/- 10 mm



Length (m)	Width (m)	Height (m)	Weight (kg)	PU (pcs.)	Article no.	Price (€)
1,00	0,24	0,04	1,50	80	009203	10,20
1,50	0,24	0,04	2,25	80	010360	12,30

**STARTING COLLAR**



- With perforated disc
- Forms the scaffold base together with base jacks
- Vertical standards is placed in the starting collar for further assembly



Length (m)	Weight (kg)	Article no.	Price (€)
0,23	1,40	004833	15,30
0,43	2,50	004525	39,40

**VERTICAL STANDARD WITH EXTRUDED TUBE CONNECTOR**



- Steel tube  $\varnothing$  48.3 x 3.2 mm, hot dip galvanized
- Drilled in the upper and lower part for tension-proof connection
- Perforated discs at a distance of 0.50 m for up to eight connections
- Posts with extruded tube connectors upto a certain height can also be used for suspended scaffolds or when moving by crane



Height (m)	Weight (kg)	PU (pcs.)	Article no.	Price (€)
0,50	3,20	80	000696	25,70
1,00	5,20	40	000706	33,10
1,50	7,70	40	000719	47,10
2,00	9,80	40	000727	53,90
2,50	12,10	40	000764	73,60
3,00	14,40	40	000738	80,00
3,50	16,70	40	002892	95,80
4,00	18,50	40	000745	102,50

**VERTICAL BASE STANDARD**



- Steel, hot dip galvanized
- With additional lower perforated disc
- As an alternative for use in the lowest scaffold level without a starting collar



Height (m)	Weight (kg)	PU (pcs.)	Article no.	Price (€)
0,66	4,20	40	005751	37,00
1,16	6,50	40	005752	50,70
2,16	11,00	40	004712	74,60
3,16	15,40	40	005753	104,80

## VERTICAL STANDARD WITHOUT TUBE CONNECTOR



- Steel tube  $\varnothing$  48.3 x 3.2 mm, hot dip galvanized
- For tensile strength in upper and lower part drilled
- Perforated discs at a distance of 0.50 m for up to 8 connections
- But drilled twice at top and bottom
- In connection with the screw-in tube connector (Article no. 005114), the optimal solution for suspended scaffolding

Height (m)	Weight (kg)	PU (pcs.)	Article no.	Price (€)
0,50	2,80	40	000697	27,80
1,00	4,30	40	000707	35,30
1,50	6,80	40	000720	50,40
2,00	8,90	40	000728	57,90
2,50	11,20	40	000765	79,00
3,00	13,50	40	000739	85,70
4,00	17,60	40	000746	106,10



## TUBE CONNECTOR FOR VERTICAL STANDARD



- Including two special screws M 12 x 65 (Article no. 010697) and two locking nuts (Article no. 005817)

Length (m)	Weight (kg)	Article no.	Price (€)
0,52	2,00	005114	13,40



## HEXAGON BOLT M12 X 65



- For fixing the tube connector (Article no. 005114) to the vertical standard



Weight (kg)	PU (pcs.)	Article no.	Price (€)
0,06	100	010697	3,80

## SELF-LOCKING NUT M12



- For fixing the tube connector (Article no. 005114) to the vertical standard



Weight (kg)	PU (pcs.)	Article no.	Price (€)
0,02	200	005817	0,60

## TUBE FOLDING PLUG 12 X 60



- Galvanized

Weight (kg)	PU (pcs.)	Article no.	Price (€)
0,085	100	012057	10,00



**SUSPENDED SCAFFOLD CONNECTOR** 

- Steel, hot dip galvanized
- Installed in pairs
- Can be used for tension-free connection of post ends when using as suspended scaffold or when moving by crane
- Permissible load: 18 kN

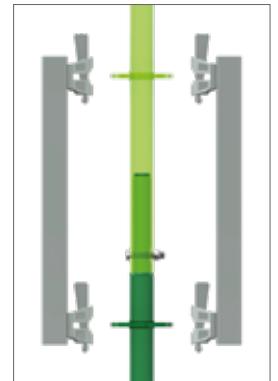

Length (m)	Weight (kg)	Article no.	Price (€)
0,50	3,61	005115	43,00

**TUBE CONNECTOR**  

- Steel, hot dip galvanized
- With U-bracket
- For wedge head connection
- For use for lattice, tubes or ledger (Not for U-Ledger)



Length (m)	Weight (kg)	Article no.	Price (€)
0,20	1,90	009726	27,60

**TUBE CONNECTOR WITH HALF COUPLER** 

- Steel, hot dip galvanized
- Screw fitting for lattice beams tube or ledger



Length (m)	Weight (kg)	A/F	Article no.	Price (€)
0,30	1,80	22	000223	27,60
0,30	1,80	19	000222	27,60

**TUBE CONNECTOR WITH U-BACKET** 

- Steel, hot dip galvanized
- For further construction e.g. for bridging while maintaining the scaffold grid



Länge (m)	Gewicht (kg)	SW	Art.-Nr.	Preis (€)
0,30	2,00	19	008290	33,70

## SECURITY PIN



- For securing the scaffold joints against unintentional lift off, for example, when moving scaffold units with a crane or in special wind conditions



Diameter (cm)	Weight (kg)	PU (pcs.)	Article no.	Price (€)
0,90	0,15	100	000508	1,40
1,10	0,15	100	006241	1,50

## PROTECTIVE SLEEVE

- Plastic
- For covering the perforated disk



Weight (kg)	PU (pcs.)	Article no.	Price (€)
0,06	40	009772	7,00

## TUBE PROTECTION ONE-PIECE

- Protective cap for tube  $\varnothing$  48.3 mm



Model	Weight (kg)	PU (pcs.)	Article no.	Price (€)
1-reflector	0,10	60	011281	3,60

## TUBE PROTECTION TWO-PIECE

- Protective cap for tube  $\varnothing$  48.3 mm



Model	Weight (kg)	PU (pcs.)	Article no.	Price (€)
2-reflector	0,15	60	011282	3,80

## LEDGER



- Steel, hot dip galvanized
- With wedge head connections for attachment to the perforated discs
- For use as a support ledger for holding decks with tube support, as bracing element and as guard rail
- In deck levels bracing ledgers can be omitted if system decks and these are secured against taking off



Length (m)	Weight (kg)	PU (pcs.)	Article no.	Price (€)
0,39	2,00	100	006232	31,40
0,42	2,00	100	005754	31,40
0,45	2,20	100	008250	31,40
0,50	2,20	100	004834	29,00
0,73	3,50	50/100	000699	25,40
1,00	4,00	50/100	000809	30,90
1,04	3,90	50/100	005755	30,20
1,09	4,50	50/100	000709	30,30
1,29	5,30	50/100	000714	37,10
1,40	5,80	50/100	000715	37,10
1,54	6,06	50/100	005756	37,10
1,57	6,40	50/100	000722	37,10
2,07	7,80	50/100	000730	43,40
2,57	9,70	50/100	000734	49,50
3,07	11,00	50/100	000741	55,80
4,14	14,90	100	004860	81,40

## REINFORCED LEDGER



- Steel, hot dip galvanized
- With wedge head connections
- To support platforms for tube support with higher loads



Width (m)	Weight (kg)	PU (pcs.)	Article no.	Price (€)
1,09	6,90	50	000767	63,50
1,29	7,80	50	000768	70,80
1,40	8,50	50	013771	74,30



## DOUBLE LEDGER



- Steel, hot dip galvanized
- With wedge head connections
- With bracing joist to support platforms with tube support for high loads or larger spans



Width (m)	Weight (kg)	PU (pcs.)	Article no.	Price (€)
1,57	9,70	50	000771	76,20
2,07	12,80	50	000772	92,10
2,57	15,90	50	000773	108,00
3,07	19,00	50	000774	123,90

## DECK LEDGER U-SUPPORT



- Steel, hot dip galvanized
- With wedge head connections
- For supporting serial UNI-CONNECT decks



Width (m)	Weight (kg)	PU (pcs.)	Article no.	Price (€)
0,42	2,20	200	004284	29,90
0,73	3,10	50/100	000821	29,20
1,04	4,20	50/100	005572	44,60
1,09	4,50	50/100	000822	42,80
1,40	5,60	50/100	000823	62,60



## DECK LEDGER REINFORCED U-SUPPORT



- Steel, hot dip galvanized
- With wedge head connections
- For supporting serial UNI-CONNECT decks with higher loads

Width (m)	Weight (kg)	PU (pcs.)	Article no.	Price (€)
1,54	9,00	50/100	005757	82,20
1,57	10,20	50/100	012174	82,20
2,07	13,70	50/100	013983	98,40
2,57	17,10	50/100	013984	114,00
3,07	20,50	50/100	013985	130,10



## DOUBLE LEDGER U-SUPPORT



- Steel, hot dip galvanized
- With wedge head connections
- With bracing joist to support serial UNI-CONNECT decks with high loads or larger spans



Width (m)	Weight (kg)	PU (pcs.)	Article no.	Price (€)
1,57	9,80	50	002716	82,20
2,07	12,80	50	002741	98,40
2,57	16,00	50	005138	114,00
3,07	19,20	50	002471	130,10

## LATTICE BEAM U-SUPPORT



- Stahlrohr  $\varnothing$  48,3 x 3,2 mm, feuerverzinkt
- Mit Keilkopfanschlüssen
- Lastaufnahme in Abhängigkeit von der Spannweite gemäß gesonderter Belastungstabelle



Length (m)	Width (m)	Weight (kg)	PU (pcs.)	Article no.	Price (€)
2,07	0,50	20,22	25	014570	208,40
2,57	0,50	27,00	25	014571	229,90
3,07	0,50	34,50	25	014572	262,00

## INTERMEDIATE DECK LEDGER DECK TO DECK



- Stahl, feuerverzinkt
- Als Zwischenaufleger für kürzere Böden bei Aussparungen und Aufgängen
- Werden auf beiden Seiten auf Stahlböden aufgeschoben
- Belastbar bis Lastklasse 3

Width (m)	Weight (kg)	Article no.	Price (€)
0,32	3,30	005662	36,70
0,64	4,50	005663	40,80
0,96	5,70	005664	46,20

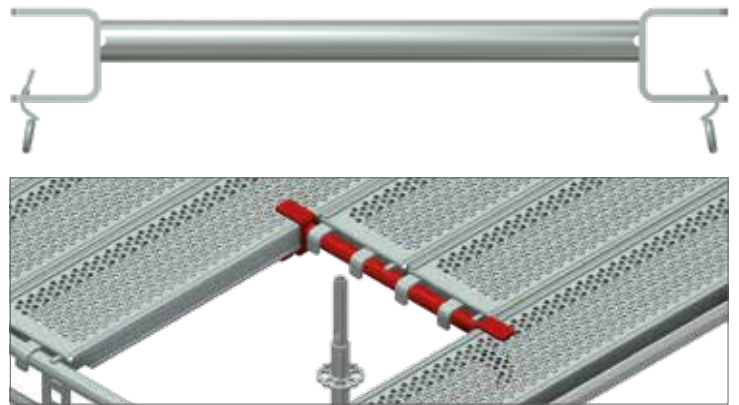

## INTERMEDIATE DECK LEDGER EDGE



- Steel, hot dip galvanized
- As intermediate support at the end of shorter platforms
- Are placed on one side on steel platforms and on the other side on longitudinal ledgers

Width (m)	Weight (kg)	Article no.	Price (€)
0,32	2,70	005665	36,70
0,64	3,80	005666	43,50
0,96	4,90	005667	53,30



## INTERMEDIATE LEDGER



- Steel, hot dip galvanized
- For supporting system-free scaffold boards or for access decks with tube support
- Are placed on longitudinal ledgers

Width (m)	Weight (kg)	Article no.	Price (€)	Preis (€)
0,73	3,70	50	000704	27,90
1,09	5,00	50	000712	32,50
1,40	6,10	50	000717	42,20
1,57	6,70	50	000726	45,20
2,07	8,40	50	000761	55,40
2,57	10,20	50	000775	66,30
3,07	12,00	50	000776	75,50

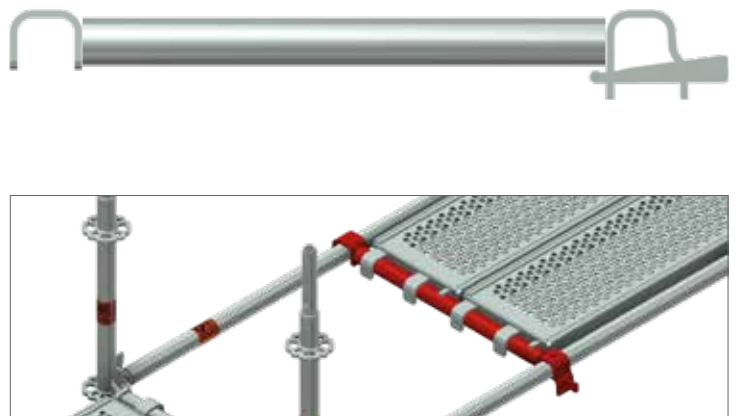

## VERTICAL DIAGONAL BRACE



- Steel tube  $\varnothing$  48.3 x 2.3 mm, hot dip galvanized
- With swiveling wedge heads
- For bracing the vertical scaffold structure

Field height (m)	Length (m)	Weight (kg)	PU (pcs.)	Article no.	Price (€)
0,50	1,57	6,40	50	004932	53,00
0,50	2,07	7,80	50	004931	55,20
0,50	2,57	9,30	50	004930	59,00
0,50	3,07	10,90	50	004929	63,40

Field height (m)	Length (m)	Weight (kg)	PU (pcs.)	Article no.	Price (€)
1,00	0,50	4,70	50	004946	50,10
1,00	0,73	4,20	50	006753	43,30
1,00	1,00	5,40	50	004943	49,30
1,00	1,04	6,25	50	005544	45,90
1,00	1,09	6,30	50	000810	45,90
1,00	1,29	6,40	50	005761	49,00
1,00	1,40	6,90	50	000811	51,70
1,00	1,54	7,00	50	005762	52,70
1,00	1,57	7,10	50	000812	54,30
1,00	2,07	8,40	50	000813	56,70
1,00	2,57	9,80	50	000814	60,50
1,00	3,07	11,20	50	000815	65,30

Field height (m)	Length (m)	Weight (kg)	PU (pcs.)	Article no.	Price (€)
1,50	0,73	5,90	50	006754	46,20
1,50	1,09	6,80	50	000816	49,20
1,50	1,40	7,20	50	000806	54,10
1,50	1,57	8,10	50	000817	56,30
1,50	2,07	9,20	50	000818	58,40
1,50	2,57	10,40	50	000819	62,10
1,50	3,07	11,80	50	000820	66,60

Field height (m)	Length (m)	Weight (kg)	PU (pcs.)	Article no.	Price (€)
2,00	0,50	7,00	50	004791	57,80
2,00	0,73	7,90	50	000702	50,50
2,00	1,00	7,60	50	004717	50,90
2,00	1,04	8,20	50	006430	51,70
2,00	1,09	8,30	50	000711	51,50
2,00	1,29	8,50	50	006689	54,60
2,00	1,40	8,70	50	000716	56,80
2,00	1,57	8,80	50	000725	53,00
2,00	2,07	9,60	50	000733	55,30
2,00	2,57	10,40	50	000737	59,10
2,00	3,07	11,20	50	000744	62,90

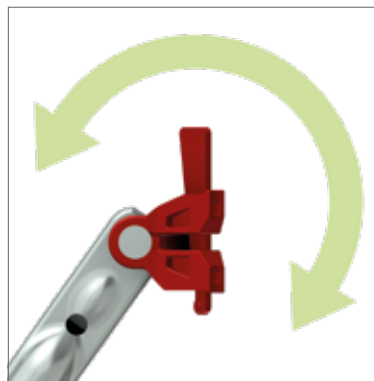

## SPACE DIAGONAL BRACE



- Steel tube, hot dip galvanized
- Variable usage at each height of the bay
- For bracing and reinforcing the horizontal levels

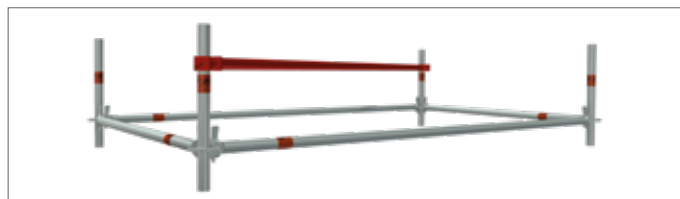

Field width (m)	Field length (m)	Weight (kg)	PU (pcs.)	Article no.	Price (€)
0,73	1,57	6,80	50	007736	49,90
0,73	2,07	8,20	50	007737	56,70
0,73	2,57	9,60	50	007738	63,10
0,73	3,07	11,10	50	007739	78,60

Field width (m)	Field length (m)	Weight (kg)	PU (pcs.)	Article no.	Price (€)
1,57	1,57	8,10	50	007744	60,90
1,57	2,07	9,40	50	007748	68,60
1,57	2,57	10,70	50	007746	77,80
1,57	3,07	12,00	50	007747	87,80

Field width (m)	Field length (m)	Weight (kg)	PU (pcs.)	Article no.	Price (€)
1,09	1,09	6,20	50	007687	46,40
1,09	1,57	7,30	50	007740	52,40
1,09	2,07	8,60	50	007741	58,80
1,09	2,57	10,00	50	007742	68,40
1,09	3,07	11,40	50	007743	82,00

Field width (m)	Field length (m)	Weight (kg)	PU (pcs.)	Article no.	Price (€)
2,07	2,07	10,40	50	007749	82,00
2,07	2,57	11,50	50	007750	86,70
2,07	3,07	12,80	50	007756	94,60

## HORIZONTAL DIAGONAL BRACE



- Steel, hot dip galvanized
- Is used in birdcage scaffolds for bracing horizontal levels in square fields
- On both sides with pin hanging system
- To be secured against lifting off on site

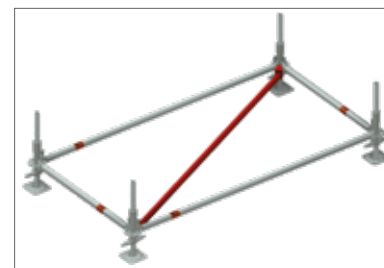
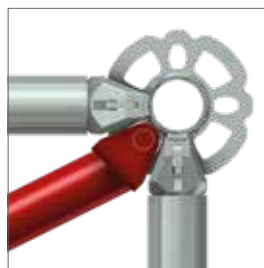

Field width (m)	Field length (m)	Weight (kg)	PU (pcs.)	Article no.	Price (€)
1,09	2,07	6,00	50	002878	52,90
0,73	2,57	7,00	50	005763	57,50
1,09	2,57	7,20	50	006393	62,90
1,57	2,57	7,60	50	010235	74,00
2,07	2,57	8,50	50	006374	81,20
1,09	3,07	8,40	50	006394	76,10

**DIAGONAL LEDGER** 

- Steel, hot dip galvanized
- Is used in birdcage scaffolds for bracing horizontal levels in square fields
- On both sides with wedge head connections

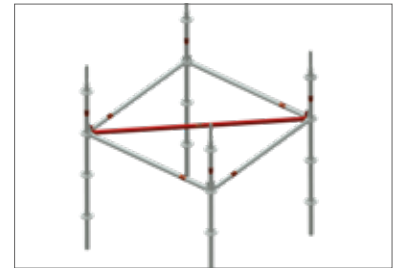
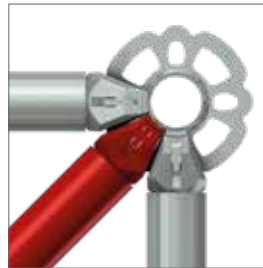

Field width (m)	Field length (m)	Weight (kg)	PU (pcs.)	Article no.	Price (€)
1,57	1,57	7,70	50	005764	57,90
2,07	2,07	10,00	50	005765	72,10
2,57	2,57	12,20	50	005766	86,20
3,07	3,07	14,50	50	005767	100,20



## STEEL DECK TUBE SUPPORT 0.19 M



- Steel, hot dip galvanized
- Non-slip surface through pronounced hole profiling
- Good stackability
- With integrated deck retainer
- Levelling deck for closing gaps in staging scaffolding and brackets

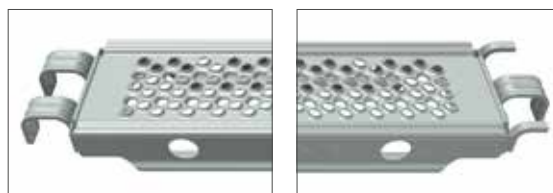

Length (m)	Width (m)	Weight (kg)	Load class	PU (pcs.)	Article no.	Price (€)
0,73	0,19	5,00	6	100/120	008750	60,10
1,09	0,19	6,70	6	100/120	008751	69,10
1,40	0,19	8,10	6	100/120	008753	70,20
1,57	0,19	9,00	6	100/120	008754	70,90
2,07	0,19	11,30	6	100/120	008755	79,00
2,57	0,19	13,70	5	100/120	008756	91,10
3,07	0,19	16,10	4	100/120	008757	103,90

## STEEL DECK TUBE SUPPORT OPTI-LINE 0,32 M



- Steel, hot dip galvanized
- Extremely robust, for the toughest operations
- Non-slip surface through pronounced hole profiling
- Reducing the wall thickness and optimized hole profiling leads to weight savings
- Good stackability due to the guide grooves at the edges



**STRONGER DUE TO  
NEW SURFACE**



Length (m)	Width (m)	Weight (kg)	Load class	PU (pcs.)	Article no.	Price (€)
0,73	0,32	5,70	6	60/80	013393	67,50
1,09	0,32	7,80	6	60/80	013394	68,30
1,40	0,32	9,50	6	60/80	013396	80,40
1,57	0,32	10,50	6	60/80	013397	78,10
2,07	0,32	13,70	6	60/80	013398	89,30
2,57	0,32	16,40	5	60/80	013399	101,70
3,07	0,32	19,10	4	60/80	013400	115,30

## STEEL DECK 0.19 M - UC



- Steel, hot dip galvanized
- Extremely robust, for the toughest operations
- Non-slip surface through pronounced hole profiling
- Reducing the wall thickness and optimized hole profiling leads to weight savings
- Good stackability due to the guide grooves at the edges



Length (m)	Width (m)	Weight (kg)	Load class	PU (pcs.)	Article no.	Price (€)
0,73	0,19	4,20	6	100/120	008780	47,70
1,09	0,19	6,40	6	100/120	008781	56,70
1,57	0,19	8,50	6	100/120	008782	58,30
2,07	0,19	10,60	6	100/120	008783	67,90
2,57	0,19	12,70	5	100/120	008784	79,40
3,07	0,19	15,90	4	100/120	008785	92,30

## STEEL DECK OPTI-LINE 0.32 M - UC



- Steel, hot dip galvanized
- Extremely robust, for the toughest operations
- Non-slip surface through pronounced hole profiling
- Reducing the wall thickness and optimized hole profiling leads to weight savings
- Good stackability due to the guide grooves at the edges
- Complies with the requirements of DIN EN 12811
- Can be used in guard and roofguard scaffolds as per DIN 4420
- Point welded

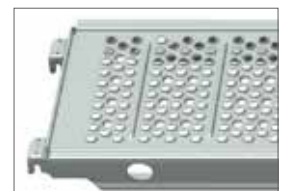

**STRONGER DUE TO  
NEW SURFACE**

Length (m)	Width (m)	Weight (kg)	Load class	PU (pcs.)	Article no.	Price (€)
0,73	0,32	5,60	6	60/80	008770	66,60
1,09	0,32	7,70	6	60/80	008771	67,80
1,40	0,32	9,30	6	60/80	011731	69,00
1,57	0,32	10,90	6	60/80	008772	69,70
2,07	0,32	13,90	6	60/80	008773	78,20
2,57	0,32	16,90	5	60/80	008774	90,30
3,07	0,32	19,80	4	60/80	008775	102,60
4,14	0,32	31,00	3	60/80	008766	200,50

## ALUMINUM DECK WITH STEEL CAPS 0.32 M



- Non-slip surface and easy to stack
- Optimized ratio of weight and carrying through computerassisted profile optimization
- Steel caps with optimized hanging claws, therefore robust and durable
- Patented beam reinforcements in the walking area ensure minimal deflection and best possible slip resistance



Length (m)	Width (m)	Weight (kg)	Load class	PU (pcs.)	Article no.	Price (€)
0,73	0,32	3,80	6	18	012323	115,90
1,09	0,32	5,10	6	18	012324	121,80
1,40	0,32	6,30	6	18	012325	124,70
1,57	0,32	6,90	6	18	012326	128,10
2,07	0,32	8,80	6	18	012327	151,10
2,57	0,32	10,70	5	18	012328	173,30
3,07	0,32	12,50	4	18	012329	199,80

## ALUMINUM DECK WITH STEEL CAPS 0.62 M



- Non-slip surface and easy to stack
- Optimized ratio of weight and carrying through computerassisted profile optimization
- Steel caps with optimized hanging claws, therefore robust and durable
- Patented beam reinforcements in the walking area ensure minimal deflection and best possible slip resistance

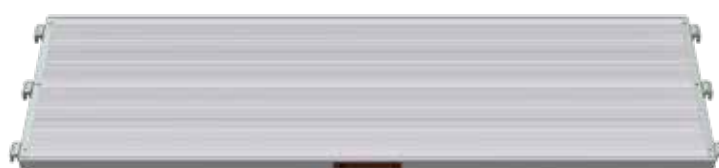

Length (m)	Width (m)	Weight (kg)	Load class	PU (pcs.)	Article no.	Price (€)
0,73	0,61	6,80	6	18	006625	131,80
1,09	0,61	8,80	6	18	006627	154,60
1,40	0,61	11,90	6	18	006629	176,10
1,57	0,61	13,40	6	18	006631	175,00
2,07	0,61	14,50	6	18	006632	212,00
2,57	0,61	17,10	5	18	006633	250,40
3,07	0,61	20,30	4	18	006634	284,50

## COMBI DECK WITH PLYWOOD PANEL - UC



- With water-resistant, non-slip and lightweight plywood panel 12 mm, BFU-100 G-12
- Robust riveted head profiles and steel connection claws, hot dip galvanized



Length (m)	Width (m)	Weight (kg)	Load class	PU (pcs.)	Article no.	Price (€)
0,73	0,61	6,30	3	14	000479	112,60
1,09	0,61	8,40	3	14	003195	126,20
1,57	0,61	13,20	3	14	000481	150,20
2,07	0,61	17,00	3	14	000482	167,50
2,57	0,61	20,00	3	14	000483	191,10
3,07	0,61	23,00	3	14	000484	226,00

## COMBI DECK TUBE SUPPORT WITH PLYWOOD PANEL



- With water-resistant, non-slip and lightweight plywood panel 12 mm, BFU-100 G-12
- Robust riveted head profiles and steel connection claws, hot dip galvanized



Length (m)	Width (m)	Weight (kg)	Load class	PU (pcs.)	Article no.	Price (€)
1,57	0,61	13,20	3	14	006038	182,10
2,07	0,61	17,00	3	14	005933	203,60
2,57	0,61	20,00	3	14	006037	231,60
3,07	0,61	23,00	3	14	005932	266,30

## STEEL PLANK 0.30 M



- Steel, hot dip galvanized
- Non-slip surface through pronounced hole profiling

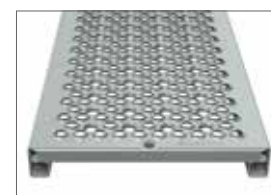

Length (m)	Width (m)	Weight (kg)	PU (pcs.)	Article no.	Price (€)	
1,00	0,30	6,75	80	013310	52,10	⌚
1,50	0,30	9,75	80	013311	61,60	⌚
2,00	0,30	12,80	80	013312	70,70	⌚
2,50	0,30	15,85	80	013313	80,30	⌚

## CORNER DECK



- Steel, hot dip galvanized
- As a supplement for system decks in the inner corner area
- Non-slip surface



Model	Length (m)	Width (m)	Weight (kg)	Article no.	Price (€)
1-bohlig	0,32	0,32	4,45	013862	89,20

## COMBI ACCESS DECK TUBE SUPPORT WITH PLYWOOD DECK



- With water-resistant, non-slip and lightweight plywood panel 12 mm, BFU-100 G-12
- With integrated aluminum ladder
- Robust riveted head profiles and steel connection claws, hot dip galvanized
- Access flap open to the back



Length (m)	Width (m)	Weight (kg)	Load class	PU (pcs.)	Article no.	Price (€)
2,57	0,61	25,50	3	14	005848	375,40
3,07	0,61	29,80	3	14	005849	411,20

## COMBI ACCESS DECK TUBE SUPPORT WITH ALUMINUM DECK



- With non-slip aluminum deck
- Weather resistant, light and robust
- With integrated ladder aluminum
- Robust riveted head profiles and steel connection claws, hot dip galvanized
- Access flap open to the back



Length (m)	Width (m)	Weight (kg)	Load class	PU (pcs.)	Article no.	Price (€)
2,57	0,61	26,60	4	14	005546	449,30
3,07	0,61	30,50	3	14	004679	493,90

## COMBI ACCESS DECK WITH PLYWOOD DECK - UC



- With water-resistant, non-slip and lightweight plywood panel 12 mm, BFU-100 G-12
- With integrated aluminum ladder
- Robust riveted head profiles and steel connection claws, hot dip galvanized



Length (m)	Width (m)	Weight (kg)	Load class	PU (pcs.)	Article no.	Price (€)
2,57	0,61	24,00	3	14	000492	359,10
3,07	0,61	29,00	3	14	000494	409,50



## COMBI ACCESS DECK



- With non-slip deck aluminum
- With integrated aluminum ladder (Length 2.07 m extendable)
- Access flap made of corrugated sheet metal with safety lock
- Easy release of the integrated access ladder, also from the soil surface possible
- Head profiles and optimized connection claws from steel, hot dip galvanized



Length (m)	Width (m)	Weight (kg)	Load class	PU (pcs.)	Article no.	Price (€)
2,07	0,61	23,30	4	14	009872	415,80
2,57	0,61	23,70	4	14	000486	423,80
3,07	0,61	26,70	3	14	000488	473,00

## COMBI ACCESS DECK WITHOUT LADDER



- With non-slip deck aluminum
- Without integrated ladder
- Access flap made of corrugated sheet metal with safety lock
- Head profiles and optimized connection claws from steel, hot dip galvanized



Length (m)	Width (m)	Weight (kg)	PU (pcs.)	Article no.	Price (€)
1,57	0,61	11,00	14	009079	279,90
2,07	0,61	17,50	14	000490	295,70
2,57	0,61	20,00	14	002250	346,40
3,07	0,61	25,00	14	000489	394,00

## ACCESS LADDER



- As a separate ladder for the inside scaffold ascent
- With riveted claws for safe mounting to the access decks



Model	Length (m)	Width (m)	Weight (kg)	PU (pcs.)	Article no.	Price (€)
Aluminium	2,16	0,40	3,00	–	001323	80,70
Steel	2,16	0,40	10,50	80	000172	79,90

## VERTICAL LADDER ALUMINUM

- Suited for all scaffold types, may also be used for ladder scaffolds
- TÜV inspected
- With riveted tube connectors
- Distance between rungs 28 cm
- Is fastened with standard couplers
- Plastic base included

Length (m)	Width (m)	Weight (kg)	PU (pcs.)	Article no.	Price (€)
2,00	0,47	5,80	20	000409	160,30
3,00	0,47	8,00	20	000410	174,50
4,00	0,47	10,00	20	000411	226,00
5,00	0,47	12,60	20	000412	275,00
6,00	0,47	14,50	20	000413	325,70

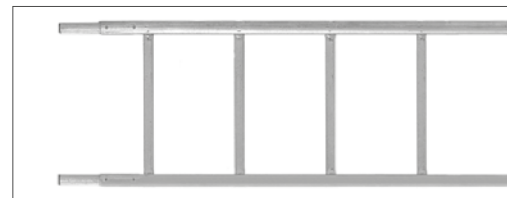

## VERTICAL LADDER STEEL

- The posts are steel tube  $\varnothing 48.3 \times 3.2$  mm, hot dip galvanized
- Standard coupler connection is ensured
- This robust ladder has become the first choice in industry for heavy-duty applications
- The ladder can be extended using normal tube connectors

Length (m)	Width (m)	Weight (kg)	PU (pcs.)	Article no.	Price (€)
2,00	0,45	21,00	20	000227	126,60
3,00	0,45	28,50	20	000228	174,70
4,00	0,45	34,50	20	000229	240,00
5,00	0,45	44,50	20	000230	309,90

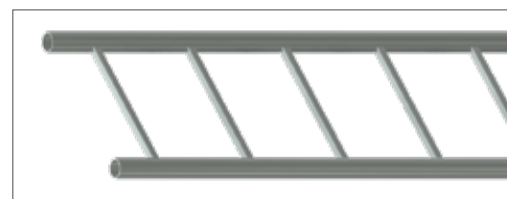

## ALUMINUM STAIRS WITH PLATFORM AND TUBE SUPPORT



- Bay height 2.00 m
- Scaffold stairway for the planned construction with facade scaffolding
- For quick and safe mounting of the scaffold levels
- The steps are designed in a non-slip manner and allow comfortable outside access for extensive use of scaffold and when transporting bulky material, without reducing the work surface in the main walkway
- Evenly distributed area load  $p = 2.5 \text{ kN/m}^2$
- Single load distributed on  $0.2 \times 0.2 \text{ m}^2 F = 1.5 \text{ kN}$
- Meets the requirements according to DIN EN 12811-1

Field length (m)	Length (m)	Width (m)	Weight (kg)	PU (pcs.)	Article no.	Price (€)
2,57	3,25	0,64	30,00	10	005069	575,70
3,07	3,65	0,64	35,00	10	005780	664,70



## ALUMINUM STAIRS WITH PLATFORM - UC



- Bay height 2.00 m
- Scaffold stairway for the planned construction with facade scaffolding
- For quick and safe mounting of the scaffold levels
- The steps are designed in a non-slip manner and allow comfortable outside access for extensive use of scaffold and when transporting bulky material, without reducing the work surface in the main walkway
- Evenly distributed area load  $p = 2.5 \text{ kN/m}^2$
- Single load distributed on  $0.2 \times 0.2 \text{ m}^2 F = 1.5 \text{ kN}$
- Meets the requirements according to DIN EN 12811-1



Field length (m)	Length (m)	Width (m)	Weight (kg)	PU (pcs.)	Article no.	Price (€)
2,57	3,25	0,64	23,00	10	000419	524,60
3,07	3,65	0,64	28,00	10	000420	639,60

## ALUMINUM BEGINNING STAIRS WITH PLATFORM - UC



- Beginning stair with integrated base jack mounts
- Scaffold stairway for the planned construction with facade scaffolding
- For quick and safe mounting of the scaffold levels
- The steps are designed in a non-slip manner and allow comfortable outside access for extensive use of scaffold and when transporting bulky material, without reducing the work surface in the main walkway



Height (m)	Length (m)	Width (m)	Weight (kg)	PU (pcs.)	Article no.	Price (€)
1,00	1,49	0,64	11,60	10	006521	340,70
1,50	1,75	0,64	18,60	15	009945	487,40

## SINGLE OUTSIDE STAIRCASE HANDRAIL



- Steel, hot dip galvanized
- To connect to the COMBI perforated disk



Field height (m)	Length (m)	Weight (kg)	Article no.	Price (€)
2,00	2,57	11,10	005071	91,60
2,00	3,07	12,60	000424	106,60

## OUTSIDE STAIRCASE HANDRAIL



- Steel, hot dip galvanized
- For aluminum platform stairs
- For connection for round ledger or guard rail brackets



Field height (m)	Length (m)	Weight (kg)	PU (pcs.)	Article no.	Price (€)
2,00	2,57	16,00	40	004603	150,80
2,00	3,07	17,80	40	004209	167,50

## INSIDE STAIRCASE HANDRAIL



- Steel, hot dip galvanized
- For aluminum platform stairs
- Can be used for field wide 2.50 and 3.00 m
- For mounting to the stair string
- Integrated end plug on the handrail for protection



Length (m)	Weight (kg)	A/F	PU (pcs.)	Article no.	Price (€)
2,25	11,50	19	20	000425	137,80
2,25	11,50	22	20	006942	137,80

## HANDRAIL BRACKET



- Steel, hot dip galvanized
- Tube support Ø 48.3 mm
- To set up a stairway in front of a scaffold field



Length (m)	Weight (kg)	Article no.	Price (€)
0,10	0,70	005781	19,40

## STAIR TOWER

U-STAIR STRINGER 

- Steel, hot-dip galvanized
- Integrated covering for UC steel decks 0.32 m
- 2-stage version with half coupler at the top and wedge head at the bottom
- 8-stage version with two wedge heads
- Gradient 16.60 cm



Model	Field length (m)	Field height (m)	Weight (kg)	PU (pcs.)	Article no.	Price (€)
2-stage	0,73	0,50	8,90	28	011019	198,60
5-stage	1,57	1,00	19,60	28	011167	326,90
8-stage	2,57	1,50	35,00	28	010950	480,60

## RODS STAIR RAILING



- Steel, hot-dip galvanized
- For installation in the MJ stair tower
- With hook/bolt heads for attachment to the module plate



Length (m)	Height (m)	Weight (kg)	PU (pcs.)	Article no.	Price (€)
0,73	1,10	14,00	20	010991	168,90
1,09	1,10	18,00	20	010992	226,20
1,29	1,10	19,60	20	010993	238,50
1,40	1,10	20,60	20	010994	249,80
1,57	1,10	23,90	20	010995	271,10
2,07	1,10	28,40	20	010996	309,70
2,57	1,10	33,10	20	010997	354,10

## RODS STAIR RAILING FOR U-STAIR STRINGER



- Steel, hot-dip galvanized
- For installation in the MJ stair tower
- With hook/bolt heads for attachment to the module plate



Model	Field length (m)	Field height (m)	Weight (kg)	PU (pcs.)	Article no.	Price (€)
2-stage	0,73	0,50	14,00	20	011102	223,50
5-stage	1,57	1,00	25,00	20	011289	382,60
8-stage	2,57	1,50	38,00	20	011009	456,90

## GAP LEDGER FOR STAIR TOWER



- Steel, hot-dip galvanized
- Compensation element for installation in stair towers
- Use when using the stair stringer at the upper and lower transition to the platform
- With two wedge heads



Length (m)	Width (m)	Weight (kg)	PU (pcs.)	Article no.	Price (€)
0,73	0,11	5,40	50	010981	89,20
1,09	0,11	7,80	50	010982	100,20
1,29	0,11	8,60	50	010983	108,20
1,40	0,11	9,80	50	010984	112,80
1,57	0,11	10,70	50	010985	115,10
2,07	0,11	14,40	50	010986	142,40
2,57	0,11	17,80	50	010987	172,10

## U-GAP COVER WITH CLAWS



- Steel, hot-dip galvanized
- Compensation element to cover gaps between the platform elements
- With four claws
- For a gap-free transition between the platform elements



Length (m)	Width (m)	Weight (kg)	PU (pcs.)	Article no.	Price (€)
0,73	0,11	4,00	50	011020	54,80
1,09	0,11	4,40	50	011021	56,30
1,40	0,11	5,50	50	011022	58,60
1,57	0,11	6,00	50	011023	59,30
2,07	0,11	9,10	50	011024	80,10
2,57	0,11	12,00	50	011025	83,60

**DECK FASTENING U-SUPPORT** 

- Steel, hot dip galvanized
- To prevent lifting of UNI-CONNECT decks

Width (m)	Weight (kg)	PU (pcs.)	Article no.	Price (€)
0,42	0,70	-	005758	15,50
0,73	1,30	200	002222	22,60
1,04	1,70	100	005573	24,90
1,09	1,90	100	005580	24,90
1,40	2,50	100	003703	47,80
1,54	2,70	100	005759	50,50
1,57	2,75	100	004307	50,50
2,07	5,20	100	004340	58,30
2,57	6,50	100	005760	66,10
3,07	7,70	100	004599	74,00

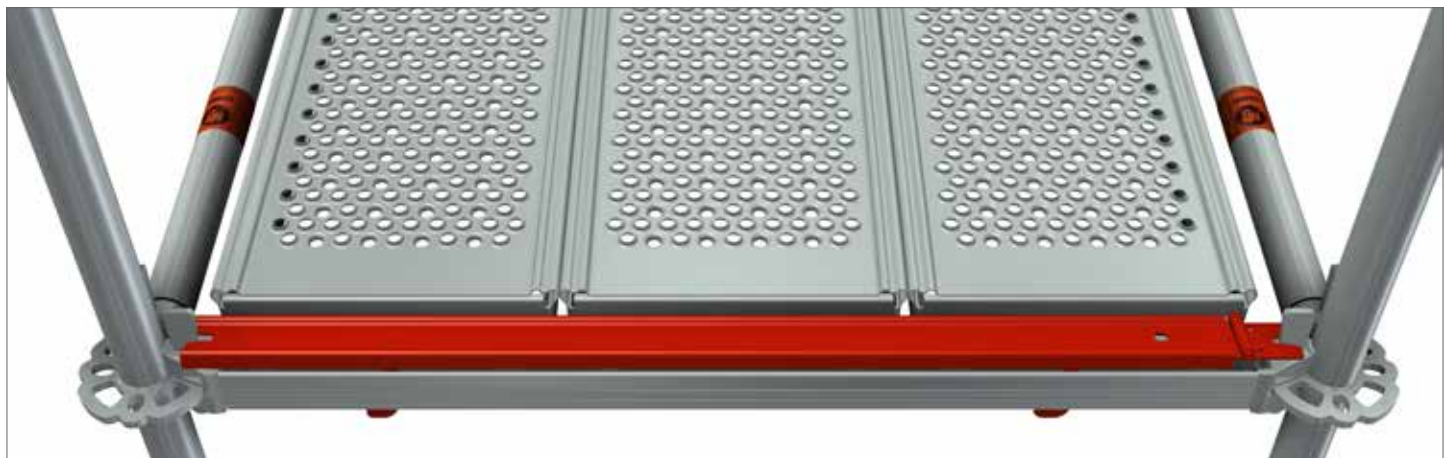

**DECK FASTENING WITH WEDGE** 

- Steel, hot dip galvanized
- For preventing decks from lifting off
- With wedge head connection

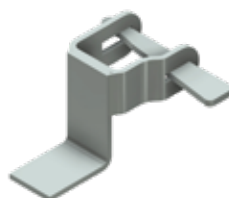

Weight (kg)	Article no.	Price (€)
0,70	006850	14,60

**DECK FASTENING WITH HALF COUPLER** 

- Steel, hot dip galvanized, drop-forged
- For securing decks against lifting off



A/F	Weight (kg)	Article no.	Price (€)
19	1,10	008156	15,80
22	1,15	008157	15,80



## TOE BOARD TUBE-SUPPORT



- Timber
- Galvanized steel fittings
- To complete the three-part side protection

Length (m)	Height (m)	Weight (kg)	PU (pcs.)	Article no.	Price (€)
0,73	0,15	1,50	80	000701	18,90
1,09	0,15	2,50	80	000710	19,60
1,40	0,15	3,10	80	000718	20,30
1,57	0,15	3,50	80	000724	21,10
2,07	0,15	4,30	80	000732	22,60
2,57	0,15	5,70	80	000736	24,20
3,07	0,15	6,30	80	000743	25,70
4,14	0,15	7,90	80	005055	45,00



## ALUMINUM TOE BOARD TUBE-SUPPORT



- Aluminum
- Galvanized steel fittings
- To complete the three-part side protection

Length (m)	Height (m)	Weight (kg)	PU (pcs.)	Article no.	Price (€)
0,73	0,15	1,30	80	005772	29,30
1,09	0,15	1,90	80	005773	35,00
1,40	0,15	2,40	80	006120	38,60
1,57	0,15	2,70	80	005774	40,60
2,07	0,15	3,40	80	005775	50,70
2,57	0,15	4,20	80	005776	60,60
3,07	0,15	4,90	80	005777	70,80



## STEEL TOE BOARD O-SUPPORT



- Steel, hot dip galvanized
- To complete the three-part side protection

Length (m)	Height (m)	Weight (kg)	PU (pcs.)	Article no.	Price (€)
0,73	0,15	1,70	–	006928	21,80
1,09	0,15	2,40	–	006929	26,50
1,57	0,15	3,30	–	006930	33,40
2,07	0,15	4,30	–	006931	39,50
2,57	0,15	5,30	–	006932	46,70
3,07	0,15	6,20	–	006933	53,60

## STEEL TOE BOARD U-SUPPORT

ID

- Steel, hot dip galvanized
- To complete the three-part side protection

Length (m)	Height (m)	Weight (kg)	PU (pcs.)	Article no.	Price (€)	
0,73	0,15	1,80	–	011312	21,80	🕒
1,09	0,15	2,50	–	011313	26,50	🕒
1,40	0,15	3,10	–	011314	31,30	🕒
1,57	0,15	3,40	–	011315	33,40	🕒
2,07	0,15	4,40	–	011316	39,50	🕒
2,57	0,15	5,40	–	011317	46,70	🕒
3,07	0,15	6,50	–	011318	53,60	🕒

## TOE BOARD U-SUPPORT



- Timber
- Galvanized steel fittings
- To complete the three-part side protection

Length (m)	Height (m)	Weight (kg)	PU (pcs.)	Article no.	Price (€)
0,73	0,15	1,50	80	005056	18,80
1,09	0,15	2,30	80	005057	19,60
1,40	0,15	3,00	80	005058	20,30
1,57	0,15	3,20	80	005059	21,00
2,07	0,15	4,30	80	005060	22,50
2,57	0,15	5,70	80	005061	24,20
3,07	0,15	5,90	80	005062	25,60
4,14	0,15	7,90	80	005063	45,00



## ALUMINUM TOE BOARD U-SUPPORT



- Aluminum
- Galvanized steel fittings
- To complete the three-part side protection

Length (m)	Height (m)	Weight (kg)	PU (pcs.)	Article no.	Price (€)
0,73	0,15	1,40	80	005831	29,30
1,09	0,15	2,00	80	005832	35,10
1,40	0,15	2,50	80	006121	38,60
1,57	0,15	2,80	80	005833	40,90
2,07	0,15	3,50	80	005834	51,00
2,57	0,15	4,30	80	005835	60,80
3,07	0,15	5,00	80	005836	70,80



## BRACKET TUBE-SUPPORT



- Steel, hot dip galvanized
- With tube connector
- With one wedge head connection
- To extend scaffold inwards or outwards



Width (m)	Weight (kg)	PU (pcs.)	Article no.	Price (€)
0,39	3,90	100	004840	50,50
0,73	4,90	20	004841	52,00

## BRACKET LEDGER TUBE SUPPORT



- Steel, hot dip galvanized
- With one wedge head connection
- To support the steel deck for tube support in the width 0.24 m or 0.32 m



Width (m)	Weight (kg)	Article no.	Price (€)
0,36	1,70	005744	22,80

## BRACKET LEDGER U-SUPPORT



- Steel, hot dip galvanized
- Without tube connector
- With one wedge head connection
- To extend scaffold with serial UNI-CONNECT decks



Width (m)	Weight (kg)	PU (pcs.)	Article no.	Price (€)
0,22	1,40	–	011691	26,90
0,32	1,80	20	012124	33,00

## BRACKET U-SUPPORT



- Steel, hot dip galvanized
- With tube connector
- With one wedge head connection
- To extend scaffold with serial UNI-CONNECT decks



Width (m)	Weight (kg)	PU (pcs.)	Article no.	Price (€)
0,39	3,90	100	002223	42,10
0,50	5,10	20	005778	48,40
0,73	6,30	20	002224	52,00

## BRACKET U-SUPPORT



- Steel, hot dip galvanized
- Without tube connector
- With one wedge head connection
- To extend scaffold with serial UNI-CONNECT decks



Width (m)	Weight (kg)	PU (pcs.)	Article no.	Price (€)
0,73	6,50	20	007309	48,40

## BRACKET U-SUPPORT



- Steel, hot dip galvanized
- Without tube connector
- With two wedge head connections
- To extend scaffold with serial UNI-CONNECT decks



Width (m)	Weight (kg)	PU (pcs.)	Article no.	Price (€)
0,73	4,70	20	015251	60,80

## BRACKET O-SUPPORT



- Steel, hot dip galvanized
- Without tube connector
- With three wedge head connections
- To extend scaffold



Width (m)	Weight (kg)	PU (pcs.)	Article no.	Price (€)
1,09	11,60	20	010885	93,00

## BRACKET U-SUPPORT



- Steel, hot dip galvanized
- Without tube connector
- With three wedge head connections
- To extend scaffold



Width (m)	Weight (kg)	PU (pcs.)	Article no.	Price (€)
1,09	12,00	20	002225	104,10

**STANDARD COUPLER** EN

- Steel, hot dip galvanized, drop-forged
- Robust model
- For right-angled connection of tubes of Ø 48.3 mm
- Class BB, EN 74-1
- To be used in the classes B and BB of the steel and aluminum tube



Thread	A/F	Weight (kg)	PU (pcs.)	Article no.	Price (€)
Standard	22	1,15	25	000325	8,60
Standard	19	1,15	25	000326	8,60
Quick	22	1,15	25	007521	9,30
Quick	19	1,15	25	007523	9,30

**SWIVEL COUPLER** EN

- Steel, hot dip galvanized, drop-forged
- Robust model
- For any angular connection of tubes of Ø 48.3 mm
- Class B, EN 74-1
- To be used in the class B of the steel and aluminum tube



Thread	A/F	Weight (kg)	PU (pcs.)	Article no.	Price (€)
Standard	22	1,35	25	000328	9,30
Standard	19	1,35	25	000329	9,30
Quick	22	1,35	25	007522	9,90
Quick	19	1,35	25	007524	9,90

**SPARE PARTS CAN BE FOUND IN OUR PRICE LIST „ACCESSORIES“.**

**SCAFFOLD TUBE STEEL** EN

- S235 Steel, hot dip galvanized
- Measurements as per EN 39
- Manufacturing length 6.00 m
- Minimum yield strength 235 N/mm<sup>2</sup>
- Connection of standard couplers allowed
- Special lengths on request



Model (mm)	Length (m)	Weight (kg)	PU (pcs.)	Article no.	Price (€)
48,3 x 3,2	1,00	3,77	61	004548	17,20
48,3 x 3,2	2,00	7,54	61	004550	31,40
48,3 x 3,2	3,00	11,31	61	004552	45,60
48,3 x 3,2	4,00	15,08	61	004554	61,80
48,3 x 3,2	5,00	18,85	61	005619	76,00
48,3 x 3,2	6,00	22,60	61	004087	85,00

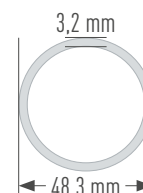

## WEDGE HEAD COUPLER FIXED

EN

- Steel, hot dip galvanized, drop-forged
- With screw cap
- For connection of scaffold tubes to the perforated disc



A/F	Weight (kg)	PU (pcs.)	Article no.	Price (€)
22	1,10	25	005859	25,70
19	1,10	25	005858	25,70

## SVIWEL WEDGE HEAD COUPLER

EN

- Steel, hot dip galvanized, drop-forged
- With screw cap
- For connection of scaffold tubes to the perforated disc



A/F	Weight (kg)	PU (pcs.)	Article no.	Price (€)
22	1,20	25	005861	28,90
19	1,20	25	005860	28,90

## WEDGE HEAD COUPLER FIXED PARALELL

EN

- Steel, hot dip galvanized, drop-forged
- For connection of scaffold tubes to the perforated disc



A/F	Weight (kg)	PU (pcs.)	Article no.	Price (€)
19	1,10	25	009947	24,20
22	1,10	25	009948	24,20

## WEDGE HEAD COUPLER DOUBLE

- Steel, hot dip galvanized

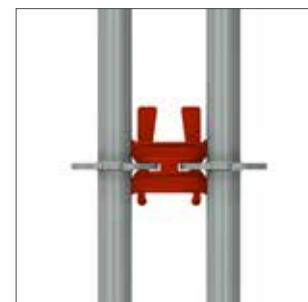

Width (m)	Weight (kg)	Article no.	Price (€)
0,15	1,20	011125	25,70

**DISTANCE COUPLER**

- Steel tube Ø 48.3 mm
- With two welded couplers, galvanized
- E. g. as connection between facade scaffold and a forward-placed stair ascent

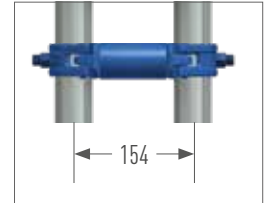

Width (m)	A/F	Weight (kg)	Article no.	Price (€)
0,110	22	1,60	008225	26,00
0,154	19	1,80	008297	26,30
0,180	22	2,00	000233	27,10

**PEFORATED DISC CLAMPABLE**

- Ensures the possibility of mounting at the desired position along a standards or tubes Ø 48.3 mm



A/F	Weight (kg)	PU (pcs.)	Article no.	Price (€)
22	1,00	25	002229	36,70
19	1,00	25	004587	36,70

**MORE COUPLERS  
FIND IN OUR PRICE LIST  
'ACCESSORIES'**



## EYE BOLT Ø 12 MM



- Galvanized and welded
- For use with plastic expansion plugs 70/100 mm and plastic caps natural / black

Length (m)	Thread Length (mm)	Weight (kg)	PU (pcs.)	Article no.	Price (€)
90	54	0,155	150	000358	1,50
120	65	0,175	150	000359	1,70
160	58	0,210	100	000360	1,90
190	65	0,235	100	000363	2,10
230	65	0,265	100	000361	2,20
300	65	0,300	50	002374	2,50
350	65	0,364	50	000362	2,70
400	65	0,424	50	006333	6,00
450	65	0,468	50	007555	6,20
500	65	0,530	50	002983	7,50



## EYE BOLT M12



- Galvanized and welded
- With metric thread

Length (m)	Thread Length (mm)	Weight (kg)	PU (pcs.)	Article no.	Price (€)
60	35	0,140	150	012379	5,00
80	35	0,150	150	012383	5,10
100	35	0,160	100	012384	5,20
120	35	0,175	100	012385	5,40
160	35	0,210	100	012386	5,60
220	35	0,260	50	012387	5,90



## PLASTIC CAP



- For closing anchor drill holes

Colour	Weight (kg)	PU (pcs.)	Article no.	Price (€)
natural	0,003	100	000651	0,20
black	0,003	100	010353	0,20



## EXPANSION PLUG



- For eye bolts with a timber thread Ø 12 mm
- For drilling Ø 14 mm

Length (m)	Weight (kg)	PU (pcs.)	Article no.	Price (€)
0,07	0,007	100	000357	0,40
0,10	0,007	100	011158	0,40



## MJ-SCAFFY



- Screw-in aid for eye bolts
- With socket A/F 22 (for standard ratchet wrenches)
- With 3/4 inch square socket
- With SDS drill adapter



Weight (kg)	Article no.	Price (€)
0,374	012600	70,60

The system free safety enclosure OPTI-BOARD is the answer to many questions that you may ask yourself when planning your construction site with regard to environmental and noise protection. When renovating or building a new building, the construction site enclosure protects employees and passers by from noise, dust and dirt.

- Light cassette: The transparent version of the OPTI-BOARD enables work in daylight conditions.
- Dust-tight: A circumferential rubber seal makes the OPTI-BOARD almost dust-tight. This enables a clean construction site cladding, the use of vacuum systems (asbestos removal) and weather-independent sandblasting.
- Quick and easy assembly
- Can be use in the UNI, UNI-CONNECT, UNI TOP, COMBI and OPTIMA systems
- Can be installed vertically and horizontally

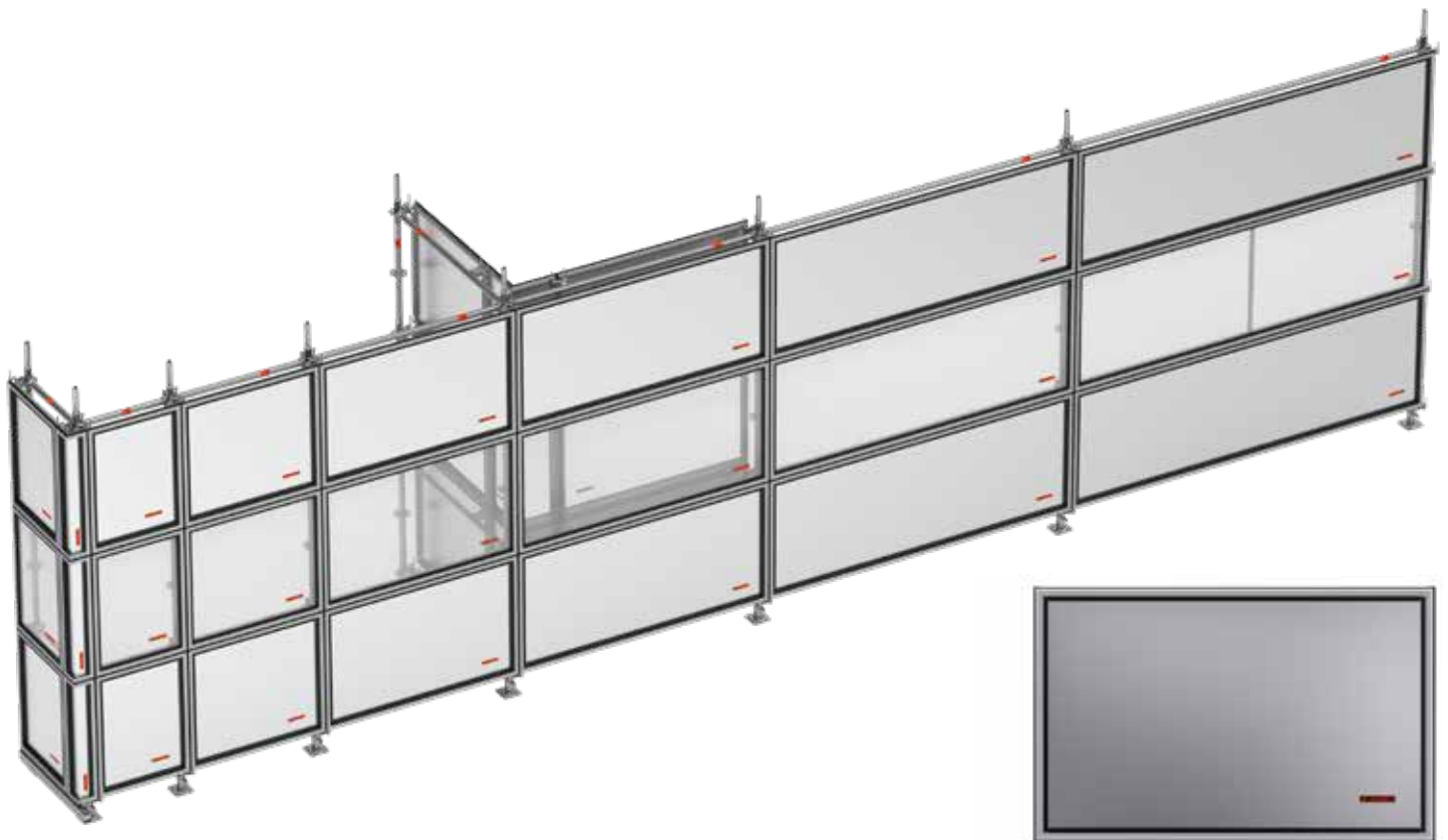

**WALLCASSETTE SHEET** 

Width	Height	Weight (kg)	PU (St.)	Article-no.	Price (€)
0,50	1,00	5,50	14	012064	172,50
0,73	1,00	6,85	14	012076	164,20
1,00	1,00	8,70	14	012065	198,50
1,09	1,00	9,20	14	012077	188,80
1,57	1,00	12,30	14	012078	218,80
2,07	1,00	15,50	14	012079	258,80
2,57	1,00	18,70	14	012080	278,80
3,07	1,00	22,50	14	012081	337,10

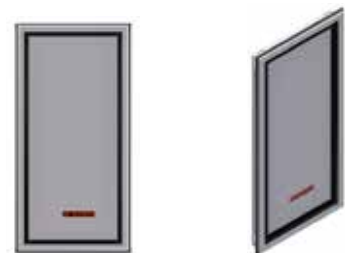

## WALLCASSETTE LIGHT



Width	Height	Weight (kg)	PU (St.)	Article-no.	Price (€)
0,50	1,00	4,30	14	012070	189,70
0,73	1,00	5,30	14	012082	180,70
1,00	1,00	6,45	14	012071	224,80
1,09	1,00	6,80	14	012083	213,90
1,57	1,00	8,90	14	012084	295,60
2,07	1,00	11,00	14	012085	345,70
2,57	1,00	13,20	14	012086	406,10
3,07	1,00	15,75	14	012087	446,10

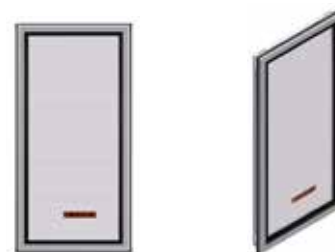

## INSIDE CORNER FOR WALLCASSETTE



Width	Height	Weight (kg)
0,40	1,00	6,85

PU (St.)	Article-no.	Price (€)
20	012088	206,10



## OUTSIDE CORNER FOR WALLCASSETTE



Width	Height	Weight (kg)
0,17	1,00	3,90

PU (St.)	Article-no.	Price (€)
50	012089	172,80



## CASSETTE HOLDER



System	Weight (kg)	PU (St.)	Article-no.	Price (€)
MODULE	1,00	250	012060	29,40
LEDGER	1,30	250	012061	33,40
TUBE	0,85	300	012062	33,40



012060



012061



012062



**STACKING PALLET FOR TUBES**



- Steel tube, hot-dip galvanized
- Specially suited for module scaffolds, e. g. standards, ledgers, guard rails, diagonal braces, tubes and toe boards
- Open all round
- Suited for stacked and crane transports
- The tubular supports are removable and are to be stowed securely in the base frame so that empty pallets can be transported and stacked in a very space-saving manner
- Special orders on request
- Push-on tube with bevel on one side, also available separately (Article no. 005791)

Length (m)	Width (m)	Weight (kg)	PU (pcs.)	Article no.	Price (€)
0,85	0,85	30,50	5	006962	232,20
1,25	0,55	31,80	5	010334	231,90
1,25	0,85	35,00	5	005614	240,20
1,50	1,05	56,50	-	012209	399,00



(Article no. 005791)



**YOU CAN FIND ADDITIONAL PRODUCTS FOR STORAGE AND TRANSPORT IN OUR PRICE LIST 'ACCESSORIES'**



## GUARD RAIL LEDGER

- Rectangular tube, hot dip galvanized
- With hook and wedge head connection for hanging in the perforated disc
- Confusion and misuse due to rectangular tube excluded
- No subsequent installation or removal possible in the form of hooks / hooks
- Reduced transport volume, lower weight



Model	Field length (m)	Weight (kg)	PU (pcs.)	Article no.	Price (€)
CO Guard rail ledger hook / wedge	1,57	3,20	50	012477	48,50
CO Guard rail ledger hook / wedge	2,07	4,50	50	012478	49,90
CO Guard rail ledger hook / wedge	2,57	6,80	50	012479	55,00
CO Guard rail ledger hook / wedge	3,07	8,10	50	012480	56,20
CO Guard rail ledger hook / hook	1,57	3,10	50	012481	35,30
CO Guard rail ledger hook / hook	2,07	4,40	50	012482	36,90
CO Guard rail ledger hook / hook	2,57	6,70	50	012483	43,00
CO Guard rail ledger hook / hook	3,07	8,00	50	012484	50,30
CO guard rail ledger hook and rotating ledger head	1,57	5,70	50	012552	53,00
CO guard rail ledger hook and rotating ledger head	2,07	5,00	50	012457	55,90
CO guard rail ledger hook and rotating ledger head	2,57	7,30	50	012458	60,30
CO guard rail ledger hook and rotating ledger head	3,07	9,60	50	012459	61,20

### Assembly sequence

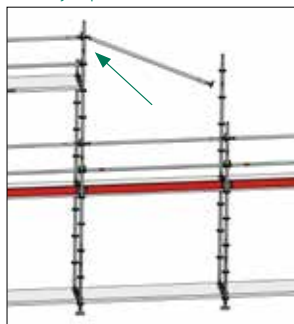

Guard rail ledger at the top with the hook side hang on the perforated disc at +3.00 m

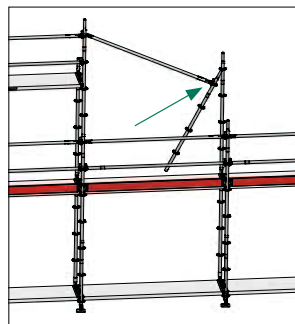

Vertical standard attach to the free ledger side

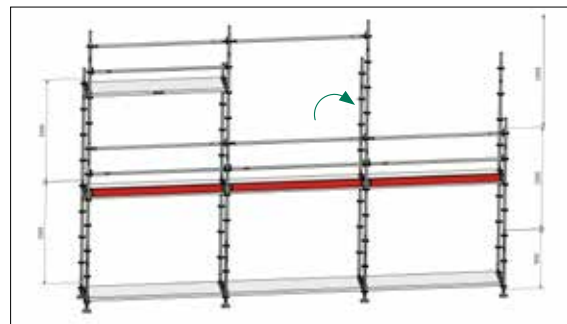

Vertical standard with guard rail ledger put on

SET - PERSONAL PROTECTIVE EQUIPMENT MILLER 1

EN N



- Revolution R2 Comfort harness – with 80 cm back eyelet extension (EN 361), elastic dura flex belt band, sharp edge tested, front and rear eyelet, comfort back pads, automatic fasteners for quick on and off, belt end clips, swivel connection at waist height for optimal ergonomics when bending or stretching, attachment point for tools and accessories, integrated label tray
- Lifetime of the material is 10 years
- Lanyards with shock absorber - length 2.00 m, sharp edges tested, horizontally approved (attachment point on foot level), 63 mm scaffold hook, stretchy design for more latitude of movement, safety clip for fastening to harness, Teflon-coated for longer life, EN 354 and EN 355
- Equipment bag - 0.27 x 0.80 m (D x H), made of PVC, red



Size	Article no.	Price (€)
S - M	006273	280,00
L - XL	005610	280,00

SET - PERSONAL PROTECTIVE EQUIPMENT MILLER 2

EN N



- Revolution R2 Comfort harness – with 80 cm back eyelet extension (EN 361), elastic dura flex belt band, sharp edge tested, front and rear eyelet, comfort back pads, automatic fasteners for quick on and off, belt end clips, swivel connection at waist height for optimal ergonomics when bending or stretching, attachment point for tools and accessories, integrated label tray
- Twin Manyard EDGE 2.00 m - with 2 x 63 mm aluminum hooks (EN 354 + 355), sharp edges tested, integrated shock absorber with fall of indicator
- Lifetime of the material is 10 years
- Equipment bag - 0.27 x 0.80 m (D x H), made of PVC, red



Size	Article no.	Price (€)
L - XL	011284	410,00

ALL SET COMPONENTS MAY ALSO BE ORDERED SEPARATELY



## KASK INDUSTRIAL CLIMBING HELMET PLASMA Q

EN ID N

- Tested and approved according to EN 397
- With chin strap
- Adjusting wheels allow one quick and easy adjustment to the right size
- With ring for attaching the helmet to a belt

Color	Article no.	Price (€)
blue	010496	74,60
white	010497	74,60
yellow	010498	74,60
orange	010499	74,60
red	010500	74,60
green	010501	74,60
dark green	010502	74,60
royal blue	010503	74,60
black	010453	74,60



## KASK INDUSTRIAL CLIMBING HELMET ZENITH

EN ID N

- Tested and approved according to EN 397 and EN 50365
- Various settings allow a quick and easy adjust
- With ring for attaching the helmet to a belt

Color	Article no.	Price (€)
blue	010504	84,70
white	010505	84,70
yellow	010506	84,70
orange	010507	84,70
red	010508	84,70
green	010509	84,70
black	010510	84,70



**OTHER PROTECTIVE EQUIPMENT FIND IN OUR PRICELIST 'ACCESSORIES'**

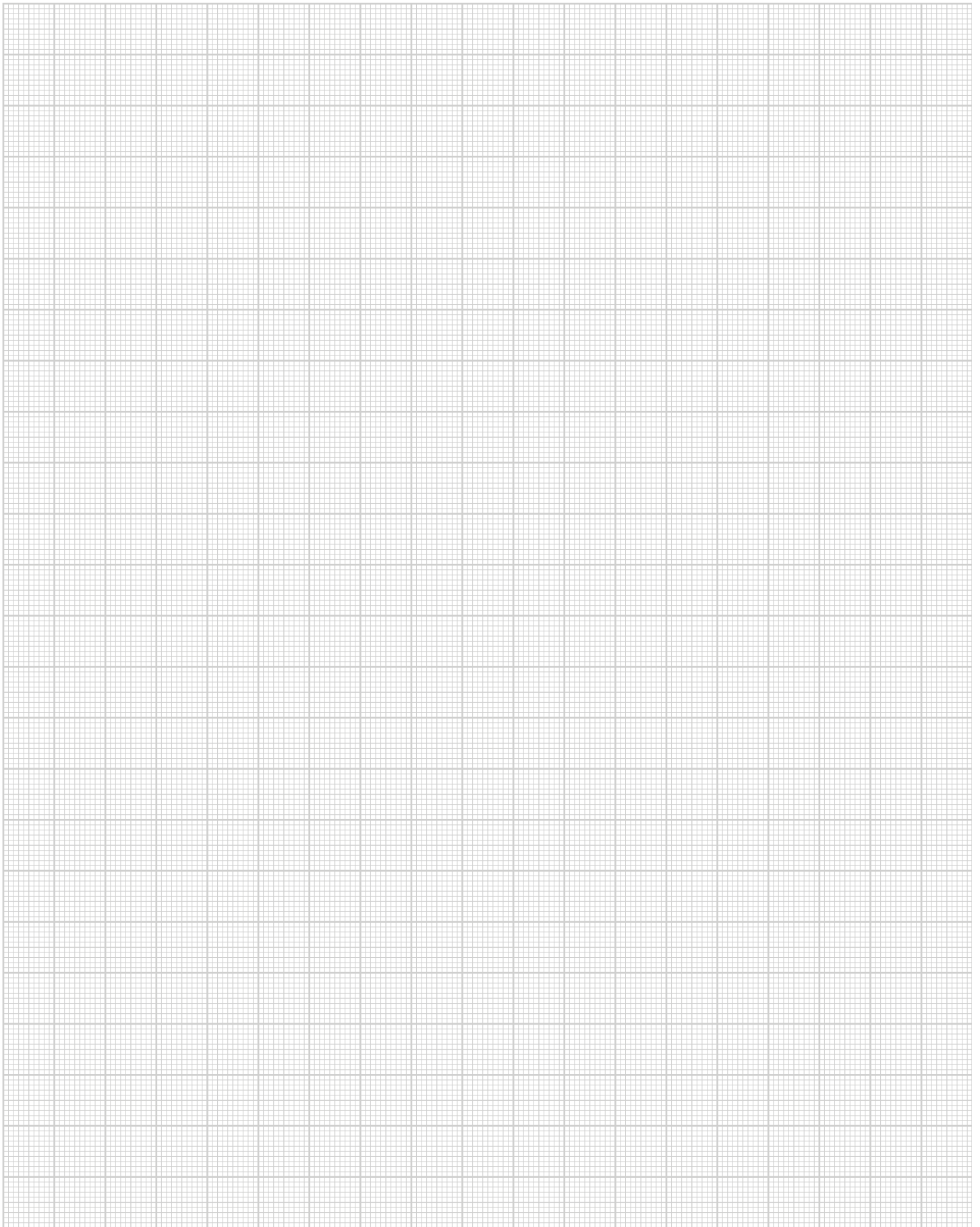





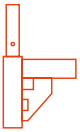

### UNI-CONNECT

07er Frame scaffold

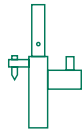

### UNI

Metric frame scaffold

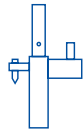

### UNI TOP

Metric frame scaffold

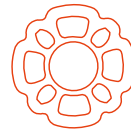

### COMBI

Modular scaffold

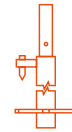

### OPTIMA

Flexible façade scaffolding

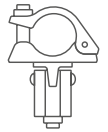

### ACCESSORIES

Universal

